

## Mounting Instructions for SP4 Power Modules

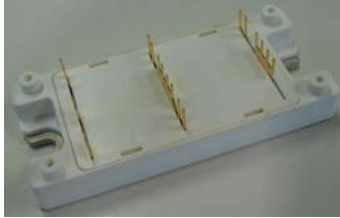

Pierre-Laurent Doumergue  
R&D Engineer  
Microsemi Power Module Products  
26 rue de Campilleau  
33 520 Bruges, France

### Introduction:

This application note gives the main recommendations to appropriately connect the PCB (Printed Circuit Board) to the power module, and mount the power module onto the heat sink. It is very important to follow the mounting instructions to limit both the thermal and mechanical stresses.

### 1. Power Module assembly onto PCB.

The PCB mounted on the SP4 power module can be screwed onto the plastic post in order to reduce all mechanical stress and minimize relative movements on the pins which are soldered onto the power module.

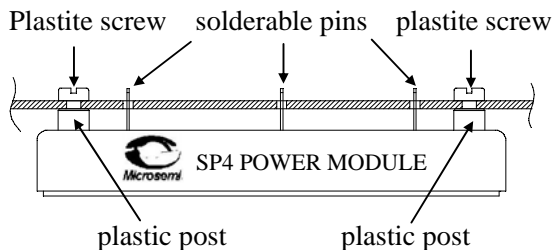

fig 1: PCB mounted on SP4 power module.

First, the PCB must be mounted onto the power module and screwed onto the plastic posts (See fig 1).

We recommend a self-tapering plastite screw with a nominal diameter of 2.5 mm.

A plastite screw is a type of screw specifically designed for use with plastic and other low density materials. (See fig 2). The screw length depends on the PCB thickness. With a 1.6 mm (0.063") thick PCB, use a plastite screw 6 mm (0.25") long. The maximum mounting torque is 0.6Nm (5 lbf-in). In any case, the customer must

check the integrity of the plastic post after screwing.



fig 2: example of plastite screw.

The second step consists of soldering all electrical pins of the power module to the PCB.

Wave soldering or manual soldering processes are recommended to solder the signal and power terminals to the PCB. The standard wave soldering temperature is 235°C (+/-5°C) for 5 seconds (+/- 1 second).

No-clean solder flux is required to attach the PCB onto the module since aqueous module cleaning is not allowed.

The PCB holes for module terminals should have a diameter of 1.5mm<sup>±0.1</sup> for an easy fit.

Do not reverse these two steps, because if all pins are soldered first to the PCB, screwing the PCB onto the plastic posts will create a deformation of the PCB, leading to some mechanical stress that can damage the tracks or break the components on the PCB.

### 2. Power module mounting onto heat sink.

Proper mounting of the module base plate onto the heat sink is essential to guarantee good heat transfer. The heat sink and the power module contact surface must be flat (recommended flatness <50µm for 100mm continuous, recommended roughness Rz 10) and clean (no dirt, no corrosion, no damage) in order to avoid mechanical stress when power module is mounted, and to avoid an increase in thermal resistance.

## 2.1 Thermal grease application.

To achieve the lowest case to heat sink thermal resistance, a thin layer of thermal grease must be applied between the power module and the heat sink. If the grease is applied onto the module base plate, a minimum thickness of 60µm (2.4 mils) of grease should be applied with a roller or a spatula.

If the grease is applied onto the heat sink, it is recommended to use screen printing technique to ensure a uniform deposition of a minimum thickness of 60µm (2.4 mils). In any case, the module bottom surface must be wetted completely with thermal grease.

## 2.2 Mounting the power module onto the heat sink.

Place the power module above heat sink holes, and apply a small pressure to it. Insert the M5 screw with lock and flat washers in each mounting hole (a #10 screw can be used instead of M5). The screw length must be at least 12 mm (0.5”).

First lightly tighten the two mounting screws. Tighten alternatively the screws until their final torque value is reached (4.7 N.m max, or 3.5 lbf-ft).

It is recommended to use a screwdriver with controlled torque for this operation.

If possible, screws can be tightened again after three hours.

The quantity of thermal grease is correct when a small amount of grease appears around the power module once it is bolted down onto the heat sink with the appropriate mounting torque (see fig 3). Figure 4 shows the thermal grease on the SP4 module base plate when removed from the heat sink.

Note: Holes in the PCB are necessary to insert and tighten the mounting screws that attach the power module to the heat sink. These access holes must be large enough for the screw head and washer to pass through freely, allowing for normal variation in PCB hole location. (See fig 5).

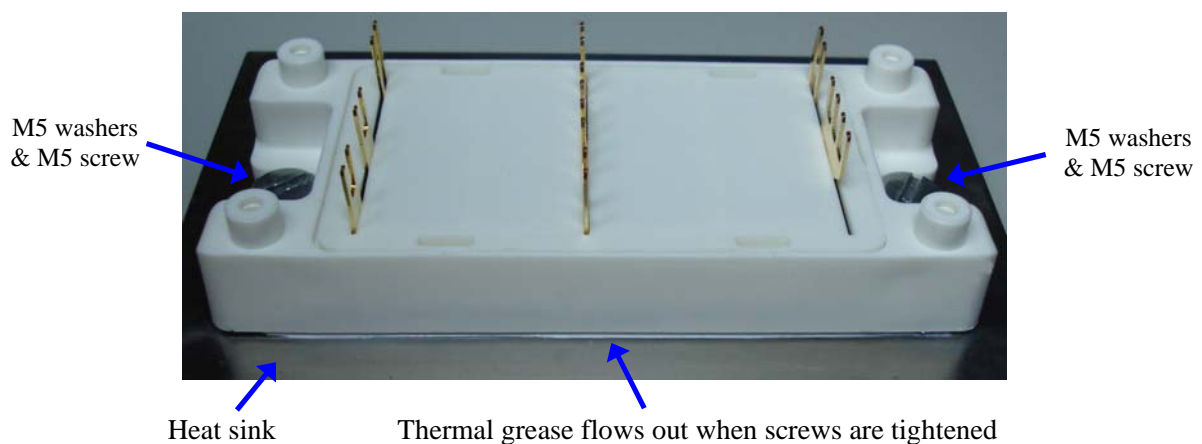

fig 3: Proper application of thermal grease to the power module.



fig 4: SP4 base plate with properly applied thermal grease after removal from heat sink.

### 3. Hole diameters in the PCB.

#### 3.1 Top view.

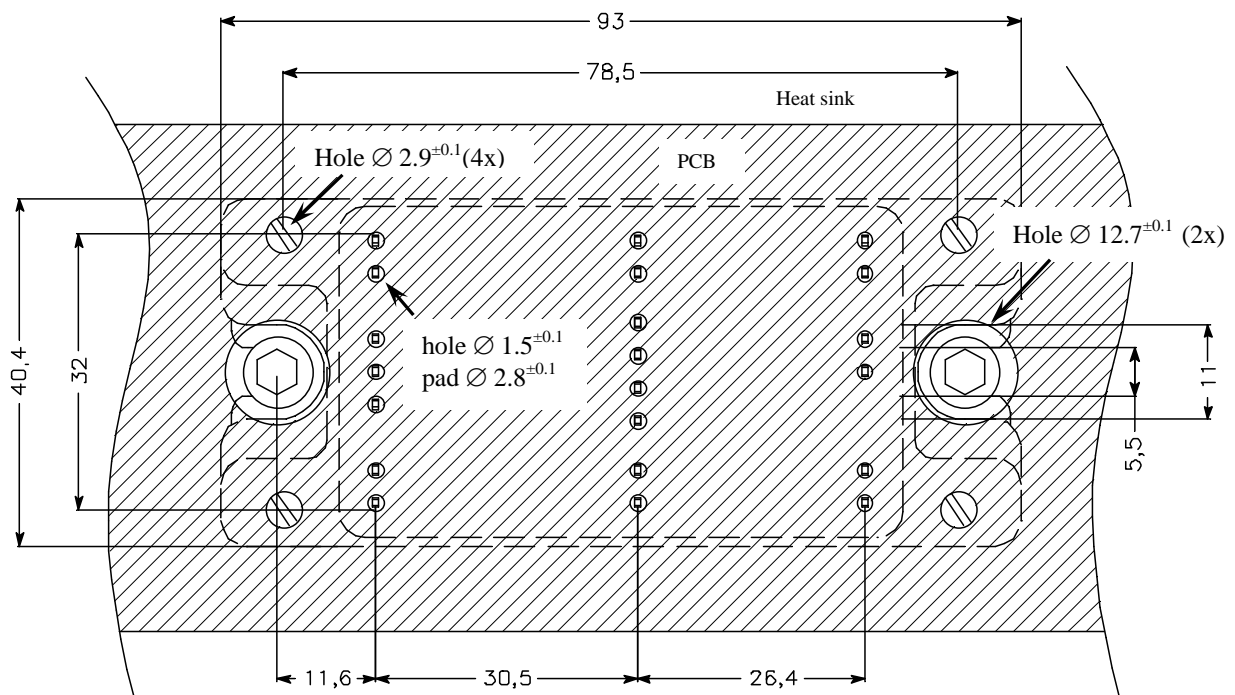

Fig 5: pad and hole diameters (in millimeters).

SP4 pinout can change according to the configuration (full bridge, boost chopper...). Each module datasheet has specific hole location information.

### 3.2 Mounting example.

Figure 6 shows the top view of a PCB mounted on an SP4 power module, and both mounted on a heat sink. Note that the

access holes in the PCB allow plenty of room for installing the module mounting screws.

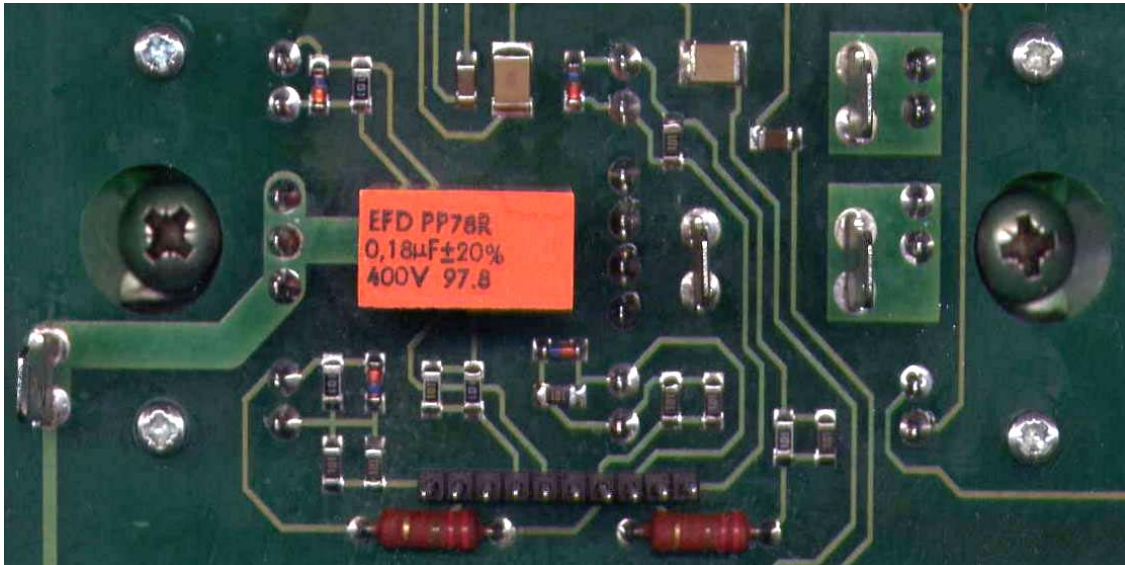

fig 6: Power module assembly on heat sink and PCB.

### 4. Mounting instructions if using a large PCB.

If a large PCB is used, additional spacers between the PCB and the heat sink are necessary. It is recommended to keep a distance of at least 5 cm between the power module and

the spacers (see fig 7). The spacers must have the same height as the plastic posts (17 mm  $\pm$ 0.5).

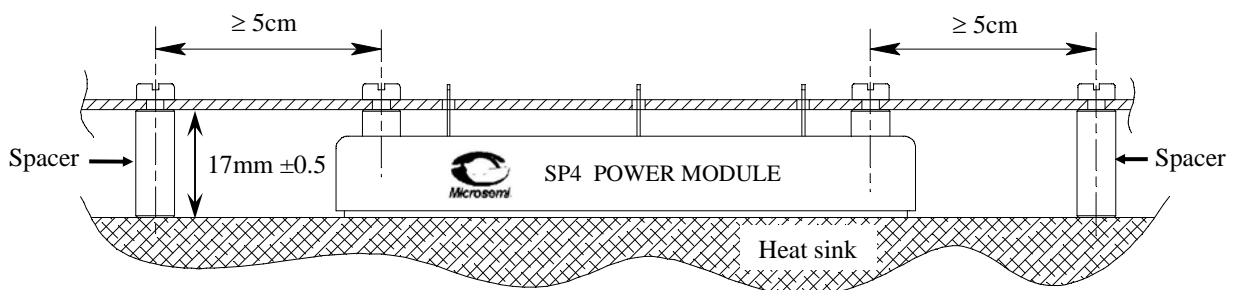

fig 7: Spacers used on large PCB.

## 5. Mounting instruction without using the plastic post.

For important temperature variations, extremely low and high temperatures or strong shock and vibration environment, screwing the PCB onto the plastic posts is not recommended. The plastic expansion leads to some mechanical stress that can damage the tracks or the components on the PCB.

On the other hand, the plastic posts may break under strong shock and vibration stress.

In order to avoid these phenomena, the utilization of metallic spacer  $18^{\pm 0.2}$  mm high is recommended to screw the PCB on top of the power module. (See fig 8).

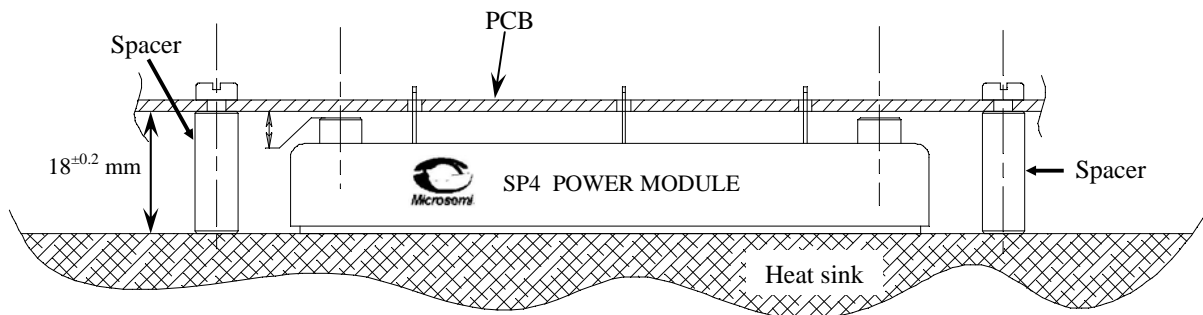

Fig 8: PCB screwed onto the metallic spacers.

## 6. Connection push-pull forces.

When the PCB is mounted onto the power module and the terminals soldered to it, some mechanical forces may be applied to the terminals. Such push or pull forces must not exceed 10N (2.25lbf) maximum per individual connector. This acceptable maximum value of push-pull force may vary depending on the mounting and operating conditions.

## Conclusion:

This application note gives the main recommendations regarding the mounting of SP4 modules. Applying these instructions will help decreasing the mechanical stress both on PCB and power module and therefore will ensure long term operation of the system. Mounting instructions to the heat sink must also be followed to achieve the lowest thermal resistance from the power chips down to the cooler. All these operations are essential to guarantee the best system reliability.